

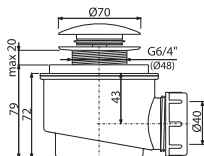

A465-50 ■ A466-50 ■ A476-50

[mm]



A465-50

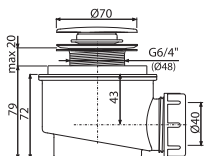
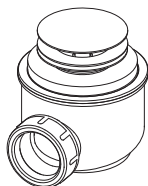

A466-50

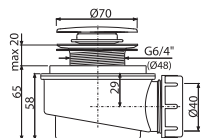
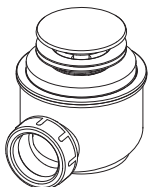

A476-50

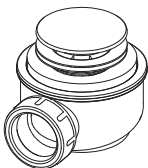

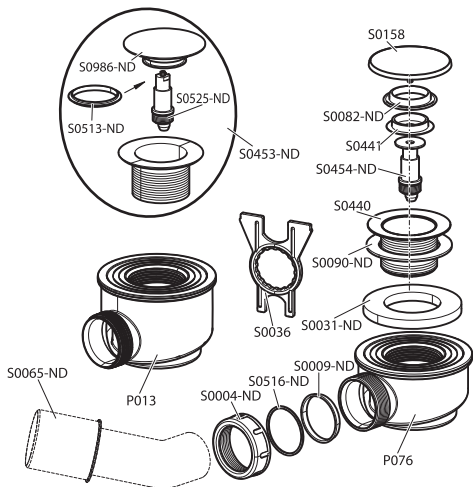

ZÍRAVINA / CAUSTIC

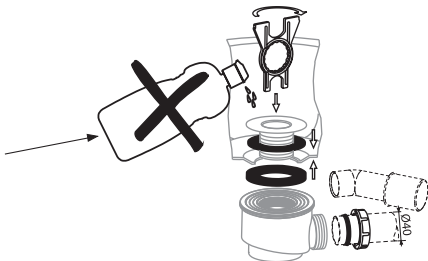

Alca plast, s. r. o.
 Bratislavská 2846, 690 02 Břeclav, Česká republika
 Tel.: +420 519 821 117 – prodej ČR
 Tel.: +420 519 821 041 – export, Fax: +420 519 821 083
 e-mail: alcaplast@alcaplast.cz, www.alcaplast.cz